



“  
myReference,,

RIGID 55

LOCK ACOUSTIC

**Gerflor**<sup>®</sup>  
theflooringroup



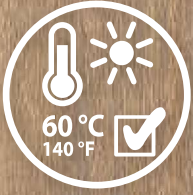

# RIGID 55

## LOCK ACOUSTIC

177 x 1219 mm

225 x 1524 mm

457 x 914 mm

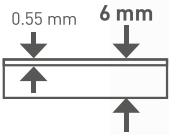

**PUR+ MATT**

Easy maintenance

**4D DESIGN**

**STRUCTURED EMOSS & BEVEL**

Ultra realistic surface

**MATT SURFACE**

Natural look

**CRISTAL WEAR LAYER**

High definition design & color

**XL FORMAT**

Wide variety of tiles & planks

**FULL RIGID CORE TECHNOLOGY**

Rigid

60 °C  
140 °F  
Max.

The best stability

Renovation ceramic  
6 mm joint

**INSULATION ULTRA**

**ACOUSTIC BACKING**

18 dB

**LOCK SYSTEM**

Standard laminate installation





RIGID **55**

LOCK ACOUSTIC

177 x 1219 mm

PUERTO

VIAJO

HOBART

SUCRE

COCHA

QUITO

UYUNI TAUPE

LOVINA

CARTAGO

VIAJO GREY



225 x 1524 mm



457 x 914 mm



XL  
PLANKS



PUNO PURE



PUNO BROWN



KILDA GOLDEN



KILDA SMOKED



KILDA CASHMERE



KILDA PEARL



XL  
TILES



TRONDHEIM



NOOSA CORTEN



BELLO



GEELONG GREY





KILDA PEARL - 0019

225 x 1524 mm



KILDA CASHMERE - 0018

225 x 1524 mm

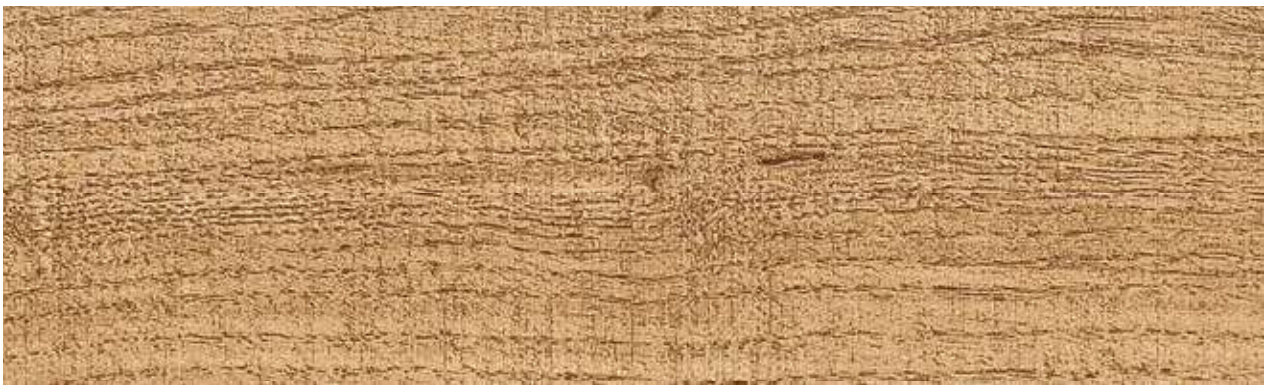

KILDA GOLDEN - 0015

225 x 1524 mm



KILDA SMOKED - 0020

225 x 1524 mm





KILDA CASHMERE



KILDA PEARL



KILDA GOLDEN



KILDA SMOKED



RIGID 55 LOCK ACOUSTIC  
PUNO WOOD COLLECTION



PUNO PURE - 0017

225 x 1524 mm



PUNO PURE





PUNO BROWN



PUNO BROWN - 0016

225 x 1524 mm





TRONDHEIM - 0011

457 x 914 mm



NOOSA CORTEN - 0014

457 x 914 mm

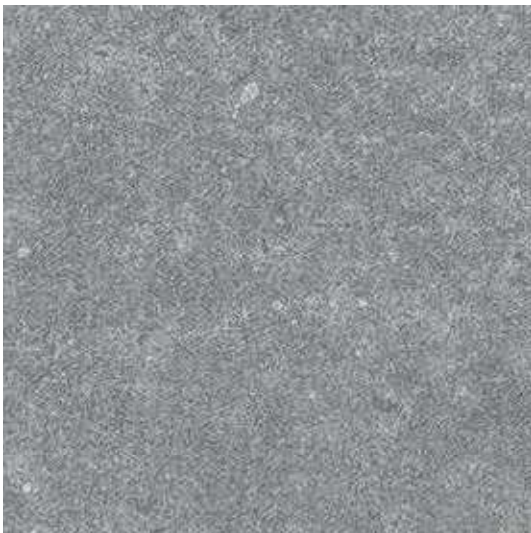

GEELONG GREY - 0012

457 x 914 mm

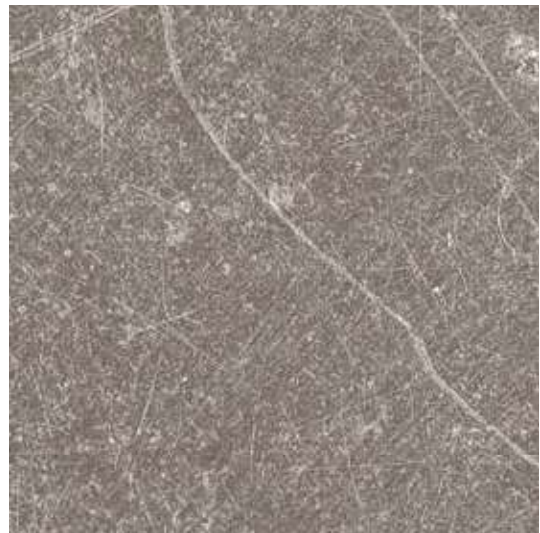

BELLO - 0013

457 x 914 mm





TRONDHEIM



NOOSA CORTEN



GEELONG GREY

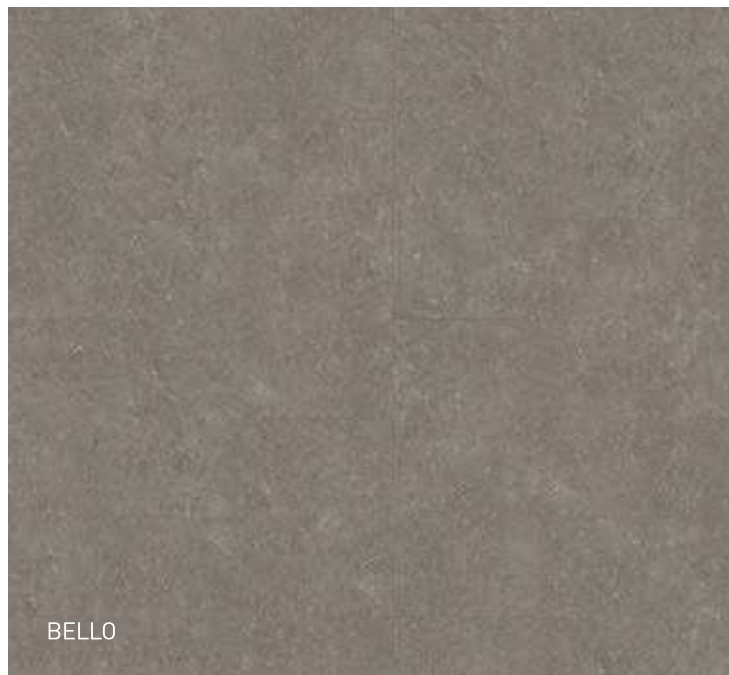

BELLO

RIGID 55 LOCK ACOUSTIC  
CLASSIC WOOD



PUERTO - 0001

177 x 1219 mm



VIAJO - 0003

177 x 1219 mm



VIAJO GREY - 0009

177 x 1219 mm



SUCRE - 0004

177 x 1219 mm



HOBART - 0002

177 x 1219 mm





HOBART



SUCRE



VIAJO GREY



PUERTO

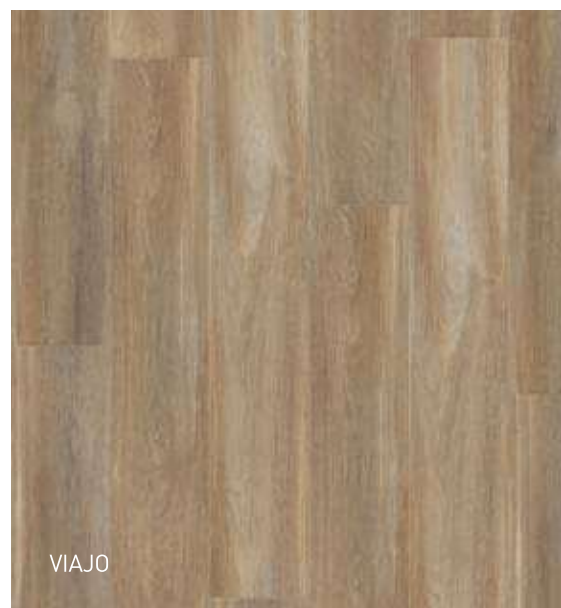

VIAJO

**RIGID 55 LOCK ACOUSTIC  
RUSTIC WOOD PLANK**



LOVINA - 0008

177 x 1219 mm



CARTAGO - 0010

177 x 1219 mm



UYUNI TAUPE - 0006

177 x 1219 mm



QUITO - 0007

177 x 1219 mm



COCHA - 0005

177 x 1219 mm



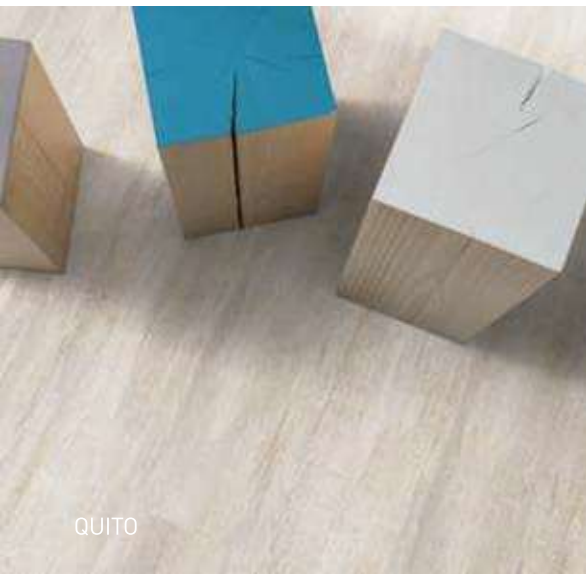

QUITO

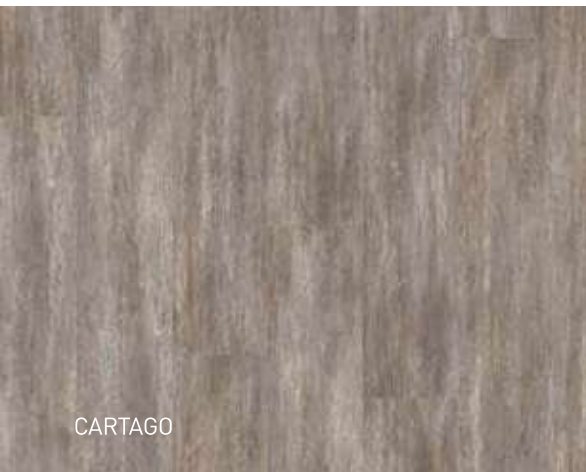

CARTAGO



COCHA



LOVINA



UYUNI TAUPE

# RIGID 55 LOCK ACOUSTIC A FULL SET OF FINISHES

## DESIGN SKIRTINGS

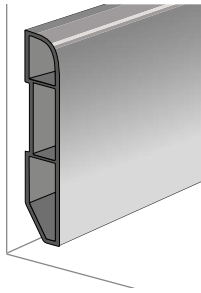
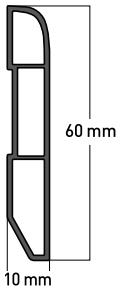

Vinyl design skirting  
Ref. 6086

- Up to 80sqm room only

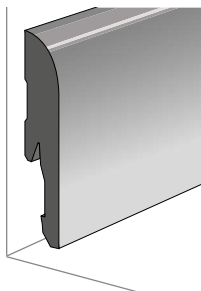
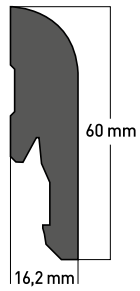

MDF design skirting  
Ref. 5947



## OTHER SKIRTINGS

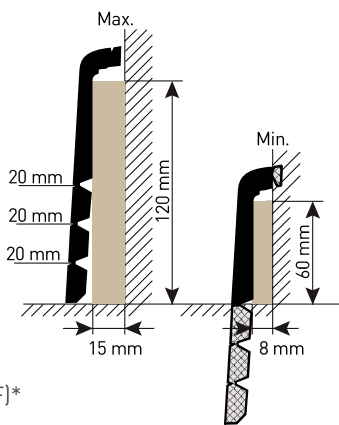

Cover skirting (MDF)\*  
Ref. 2550

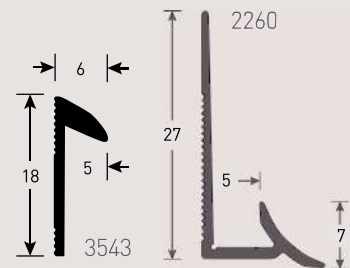

Insert skirting (aluminium)\*  
Ref. 3543 / 2260

## STAIRNOSING SOLUTION

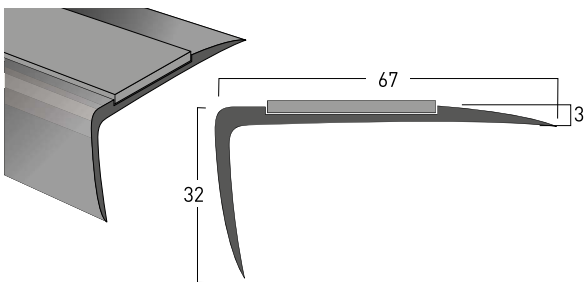

Nosing T67 (aluminium)  
Ref. 0503

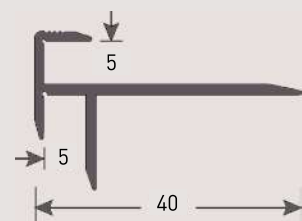

Double edge nosing, decoration series (aluminium)\*  
Ref. 1605



## PROFILES

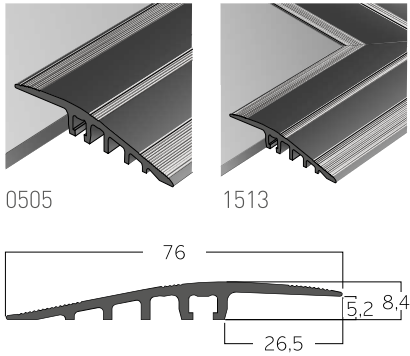

Ramp 5-6mm (aluminium)  
Ref. 0505



## ENTRANCE MATS



Looselay Romat GT insert kit  
Ref. 1719



Quick mat\*  
Ref. 8550

## FLOOR PROTECTION



Floor protection  
Ref. 058X

FOR MORE DETAILS  
visit [gerflor.com](http://gerflor.com)



LVT finishes brochure

\*Please contact Romus [www.romusworld.com](http://www.romusworld.com) or Gradus [www.gradusworld.com](http://www.gradusworld.com).  
Romus and Gradus are part of Gerflor group.

# RIGID 55 LOCK ACOUSTIC

## EQUIVALENCE RIGID 55 LOCK SYSTEM & CREATION 55

	RIGID 55 LOCK ACOUSTIC	CREATION 55 GLUE DOWN / CLIC	CREATION 55 LOOSELAY
	CARTAGO - 0010	AMADOR - 0447	AMADOR - 0447
	HOBART - 0002	BALLERINA - 0347	BALLERINA - 0347
	KILDA CASHMERE - 0018	SWISS OAK CASHMERE - 0795	-
	KILDA SMOKED - 0020	SWISS OAK SMOKED - 0847	-
	KILDA PEARL - 0019	SWISS OAK PEARL - 0846	SWISS OAK PEARL - 0846
	KILDA GOLDEN - 0015	SWISS OAK GOLDEN - 0796	SWISS OAK GOLDEN - 0796
	VIAJO - 0003	BOSTONIAN OAK - 0871	-
	VIAJO GREY - 0009	BOSTONIAN OAK GREY - 0855	-
	PUNO BROWN - 0016	CEDAR BROWN - 0850	-
	PUNO PURE - 0017	CEDAR PURE - 0849	-
	BELLO - 0013	CARMEL - 0618	CARMEL - 0618
	QUITO - 0007	ARENA - 0060	ARENA - 0060
	COCHA - 0005	MALUA BAY - 0448	MALUA BAY - 0448
	SUCRE - 0004	TWIST - 0504	SUCRE - 0004
	TRONDHEIM - 0011	NORVEGIAN STONE - 0860	NORVEGIAN STONE - 0860
	NOOSA CORTEN - 0014	RUST CORTEN - 0095	-
	UYUNI TAUPE - 0006	PAINT WOOD TAUPE - 0856	-
	LOVINA - 0008	RANCH - 0456	RANCH - 0456
	PUERTO - 0001	QUARTET - 0503	-
	GEELONG GREY - 0012	BLOOM UNI GREY - 0869	-

### INSTALLATION



LOCK SYSTEM



CUTTING WITH A SAW



# RIGID 55 LOCK ACOUSTIC

## TECHNICAL DATA

### RIGID 55 LOCK ACOUSTIC

#### DESCRIPTION / BESCHREIBUNG / BESCHRIJVING / DESCRIPTION / DESCRIPCIÓN / DESCRIÇÃO / DESCRIZIONE

Total Thickness / Gesamtdicke / Totale dikte / Épaisseur totale / Espesor total / Essessura total / Spessore totale	EN ISO 24346 [EN 428]	mm	6.00
Thickness of the wearlayer / Dicke der Nuttschicht / Dikte van de slijtlaag / Épaisseur couche d'usure / Espesor capa de uso / Essessura camada de desgaste / Spessore strato di usura	EN ISO 24340 [EN 429]	mm	0.55
Weight / Flächengewicht / Gewicht / Poids / Peso / Peso / Peso	EN ISO 23997 [EN 430]	g/m <sup>2</sup>	9480
Size / Format / Afmetingen / Format / Dimensiones / Dimensões / Dimensioe	ISO 24342 [EN 427]	mm	177x1219 225x1524 457x914

#### CLASSIFICATION / KLASSIFIKATION / CLASSIFICATIE / CLASSIFICATION / CLASIFICACIONES / CLASSIFICAÇÕES / CLASSIFICAZIONI

Norm/Product Specification / Produktnorm / Technische eigenschappen / Norme/ Spécification produit / Normas / Normas / Norma prodotto	-	-	EN ISO 10582 [EN 649]
European Classification / Europäische Klassifizierung / Europese classificatie / Classement européen / Clasificación europea / Classificação Europeia / Europea	EN ISO 10874 [EN 685]	Class	33 - 42
Avis technique	-	N° AT	12/15-1707
Fire Rating / Brandverhalten / Brand classificatie / Classement Feu / Fuego / Fogo / Reazione al fuoco	EN 13 501-1	Class	Bfl-s1
Static Electrical Propensity / Begehaufladung / Elektrische eigenschappen / Potentiel de charge / Comportamiento electrostático / Comportamento electrostático / Resistenza elettrica	EN 1815	kV	< 2
Slip Resistance Wet / Rutschhemmung / Anti-slip / Glissance humide / Deslizamiento húmedo / Escorregamento húmido / Scivolosità umida	DIN 51130 / BGR 181	Class	R10 <sup>11</sup>

#### PERFORMANCES / TECHNISCHE EIGENSCHAFTEN / TESTRESULTAAT / PERFORMANCE / CUALIDADES TÉCNICAS / PERFORMANCES / CARATTERISTICHE TECNICHE

Wear Resistance / Verschleißverhalten / Slijtvastheid / Résistance à l'usure / Abrasión / Abrasão / Resistenza all'abrasione	EN 660.2	mm <sup>3</sup>	≤ 2.0
Wear Group / Verschleißgruppe / Groep slijtvastheid / Groupe d'abrasion / Grupo de abrasión / Grupo de abrasão / Gruppo di abrasione	EN 652	group	T
Dimensional Stability / Maßstabilität / Maatvastheid / Stabilité dimensionnelle / Estabilidad dimensional / Estabilidade dimensional / Stabilità dimensionale	EN ISO 23999 [EN 434]	%	≤ 0.05
Residual Indentation / Resteindruck / Indrukbelasting / Poinçonnement statique rémanent / Punzonamiento / Punçoamento / Impronta	EN ISO 24343-1 [EN 433]	mm	≤ 0.10
Impact sound insulation / Trittschallverbesserungsmaß / Geluidsisolatie / Isolation acoustique bruits de chocs / Acústica / Isolamento acústico	EN ISO 717-2	dB	18
Room Impact / Raumschall / Loopgeluid / Sonorité à la marche / Rumore al calpestio / Sonoridad en la pisada / Sonoridade ao andar	NFS S 31074	dB	75
Castor chair test / Stuhlrollenbeanspruchung / Rolweerstand bureaustoelen / Essai de la chaise à roulettes / Determinación del efecto de una silla con ruedas / Resistência a cadeiras de rodas / Resistenza al passaggio di sed [Type W]	ISO 4918 [EN 425]	-	OK
Thermal Conductivity / Wärmeleitfähigkeit / Thermische weerstand / Conductivité thermique / Conductividad térmica / Contutividade térmica / Resistenza termica / Varmeledningsmotstånd / Varmemotstånd	EN ISO 10456 [EN12524]	W/(m.K)	0.25
Colour Fastness / Lichtechtheit / Lichtechtheid / Solidité lumière / Resistencia a la luz / Estabilidade das cores / Solidità alla luce	EN 20 105 - B02	degree	≥ 6
Surface Treatment / Oberflächenvergütung / Oppervlaktebehandeling / Traitement de surface / Tratamiento de superficie / Tratamento de superficie / Trattamento di superficie	-	-	PUR+ Matt
Chemical Products Resistance / Verhalten gegenüber Chemikalien / Chemische bestandigheid / Résistance aux produits chimiques / Resistencia a los productos químicos / Resistência aos produtos químicos / Resistenza ai prodotti chimici <sup>12)</sup>	EN ISO 26987 [EN 423]	-	OK

#### ENVIRONMENT/INDOOR AIR QUALITY / UMWELT/RAUMLUFTQUALITÄT / ENVIRONNEMENT/QUALITE DE L'AIR INTERIEUR / MEDIO AMBIENTE/CALIDAD INTERIOR DEL AIRE INTERIOR / MEIO AMBIENTE/QUALIDADE DO AR INTERIOR

TVOC after 28 days / TVOC (28 Tage) / TVOC (28 dagen) / TVOC après 28 jours / TVOC (28 dias) / TVOC (28 dias) / TVOC (28 giorni) / TVOC (28 dagar) / TVOC (28 dagar)	ISO 16000-6	µg/m <sup>3</sup>	< 100
Certification / Zeugnis / Certification / Certificado / Certificação	-	-	-

#### CE MARKING / CE KENNZEICHNUNG / EG\_CONFORMITEITSMERK / MARQUAGE CE / MARCA DE CONFORMIDAD CE / MARCA DE CONFORMIDADE CE / MARCATURA CE DI CONFORMITA

	EN 14041	-	   
---	----------	---	---

(1) Glissance humide / Slip resistance wet / Rutschhemmung : details sur site gerflor.com / details on website gerflor.com / Einzelheiten auf der web-site gerflor.com

(2) Beständig gegenüber nicht färbenden alkoholhaltigen Handdesinfektionsmitteln, Haushaltschemikalien und verdünnten Säuren und Laugen bei kurzzeitiger Einwirkung.

**Gerflor International**  
Tel: +33 (0)4 74 05 40 00  
Fax: +33 (0)4 74 05 03 13  
e-mail: gerflorcontract@gerflor.com

**Visualize your reference**



[interiordesigner.gerflor.com](http://interiordesigner.gerflor.com)

**30 years experience**  
Since 1985

**Manufacturer**  
3 LVT Factories

**World Class Logistics**  
12 Logistics Hubs

**Gerflor Design Centre**  
Exclusive Designs



**“Serenity,,**  
Elodie - **End User**



**“Time saving,,**  
Mika - **Installer**



**“Unique Design,,**  
Pierre - **Architect**



**“Confidence,,**  
Claire - **Store Manager**



**“Reliability,,**  
Lucas - **Distributor**

That's why Creation is our **Reference**

**Gerflor**<sup>®</sup>  
theflooringgroup